

# SUSPENSION THEORY GUIDE



**OVERVIEW, 3**

**SPRING, 5**

**DAMPER, 14**

**FRICTION, 21**

**CHASSIS AND GEOMETRY, 23**

**TUNING, 26**

## PURPOSE

Suspension is used to absorb shock and vibration created when the bicycle wheel impacts terrain features such as rocks, roots, dips, drops, etc. Shock absorbers (suspension forks, rear shocks) compress to absorb the energy from the impact, store it temporarily, then either release it by extending or dissipate it through damping.

Suspension is useful for a number of reasons:

- **Control** - Isolating the rider from shock to prevent loss of control
- **Traction** - Ensuring that the wheel stays in contact with the ground when needed
- **Comfort** - Isolating the rider from shock to prevent fatigue or injury
- **Durability** - Isolating the bicycle from shock to prevent damage to the bicycle

## SHOCK TRANSMISSION



Shock transmission without suspension



Shock transmission with suspension

## CONSTRUCTION

The movement of the suspension is the *stroke*, and the amount of stroke that is used for shock absorption is the *travel*.

A suspension fork or rear shock are comprised of three main elements:

- **Spring** - Manages the majority of energy created by impact to isolate the bicycle/rider from shock and vibration. The spring absorbs, stores, and releases energy.
- **Dampers (compression and rebound)** - Assists the spring in managing energy to control the speed at which the suspension can compress and extend. The damper converts energy to heat.
- **Chassis** - Houses the spring and damper, and serves as a structural member of the bicycle.

## SUSPENSION ELEMENTS

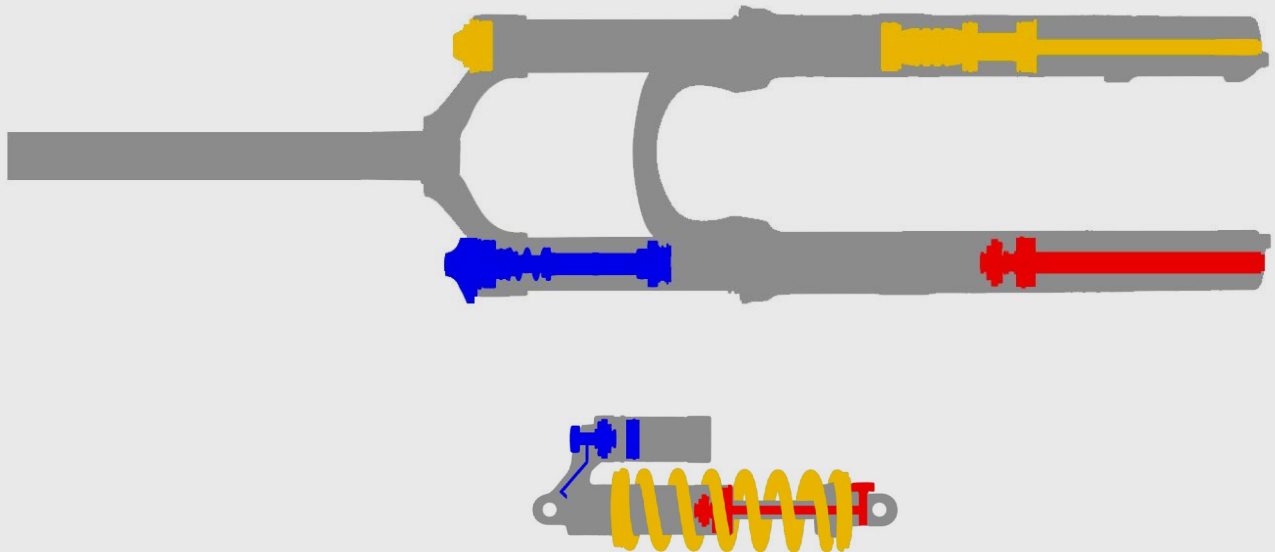

- Spring (air or coil)
- Compression damper
- Rebound damper
- Chassis



**FUNCTION**

A spring is a device that absorbs energy from an applied force. Energy is stored in the spring until the force is released, at which point the spring returns to its original uncompressed position. The energy absorption capability of a spring is measured as a *spring rate*. The spring rate is the ratio of energy absorbed, measured in pounds, per distance the spring is flexed, measured in inches. For example, if a spring requires 200 lb of force to compress one inch, it would be referred to as a *200 lb spring*.

**COIL SPRING**

A coil spring is a length of flexible wire wound into a coil. The coil shape allows the spring to flex in a linear path against itself.

Coil spring rate is determined by coil wire material (steel, titanium, carbon fiber, etc.), coil wire thickness, and the length of the active coil wire.

**THICKER WIRE DIAMETER = HIGHER RATE (MORE MATERIAL TO FLEX)**

**LONGER WIRE LENGTH = LOWER RATE (MORE LEVERAGE AGAINST THE SPRING)**

Distance between coils, coil diameter, and length of the coil do not affect spring rate, but do determine the overall dimensions of the coil.

A coil spring has a linear spring rate. As the coil is compressed, the amount of compression force will increase at a linear ratio to the distance it is compressed. For example, if one inch of stroke requires 200 lb of force, two inches would require 400 lb.

**COIL BIND**

Coil bind occurs when coils come in contact with each other during compression. Bound coils do not factor into the spring rate.

**COIL SPRING RATES**

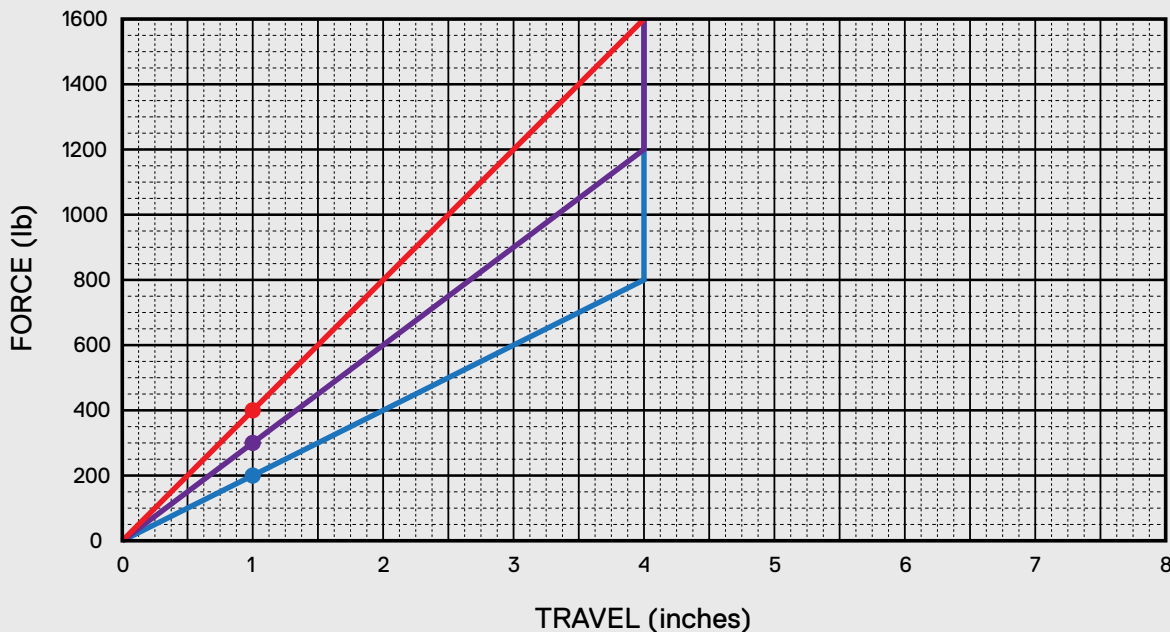

- 200 lb coil spring with 4" of compression before coil bind
- 300 lb coil spring with 4" of compression before coil bind
- 400 lb coil spring with 4" of compression before coil bind

**DUAL/PROGRESSIVE RATE COIL SPRINGS**

Dual rate and progressive springs have varying coil spacing along the spring's length. During compression, sections of the spring that are more closely spaced will coil bind, leaving a shorter, stiffer spring for the remainder of the stroke. The result is one spring rate during the first part of the stroke, transitioning to a higher rate through the remainder of the stroke. A Dual Rate Coil Spring has a sudden change in spring rate while a Progressive Rate Coil Spring has a more gradual rate change.

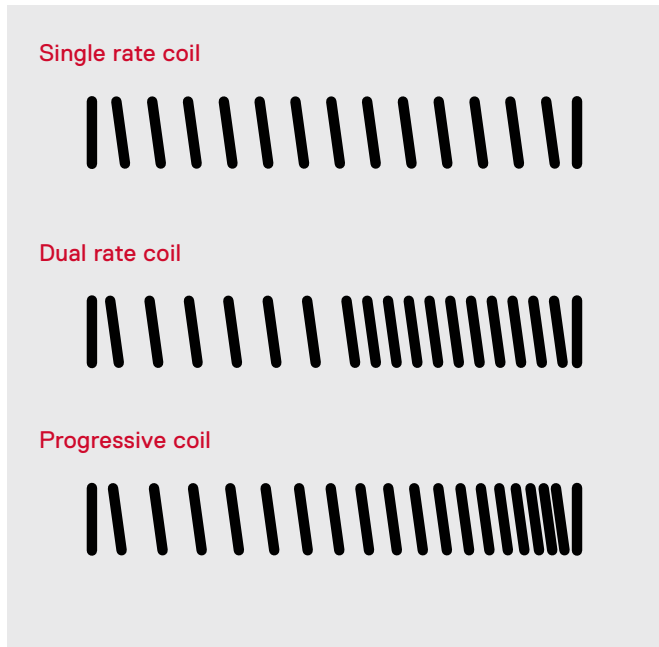

**COIL DEFLECTION**

Longer coils tend to flex outward during compression. The greatest amount of the flex typically occurs toward the middle of the coil's length.

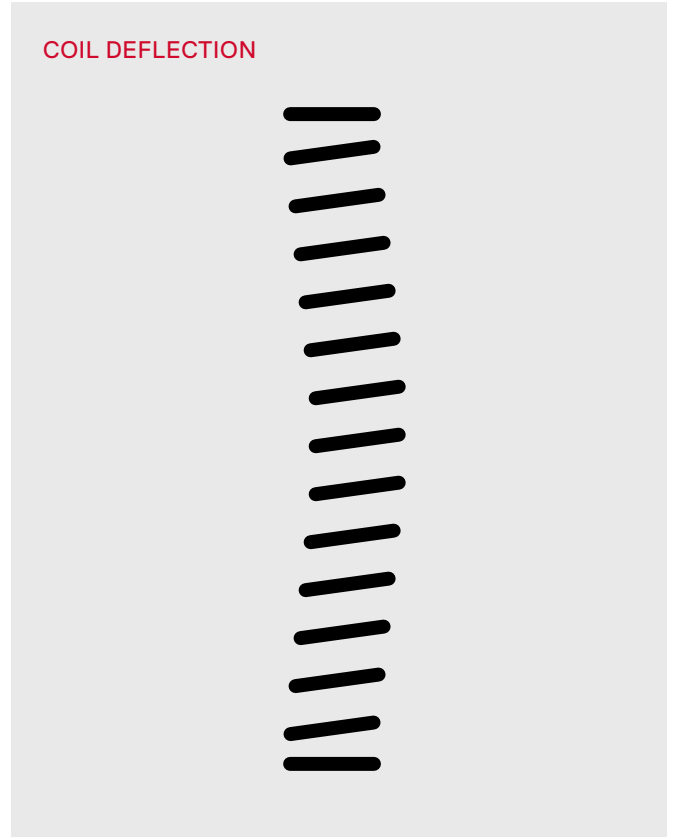

**BREAKAWAY FORCE**

When a spring is compressed, it exerts a force against whatever is compressing it. This is called a *breakaway force*. In order to further compress the spring, the breakaway force must be overcome.

**PRELOAD**

A coil spring at rest is not under pressure and creates no breakaway force. Preloading a coil spring compresses the spring without initiating stroke. This results in a breakaway force and stiffer spring feel.

**COIL SET**

After long periods of compression, such as frequent use, constant preload, or both, a coil spring will fatigue and no longer extend to its original length. This is called *coil set*. Coil set doesn't change the spring rate, only the length of the coil. A preload adjuster or spacers can compensate for the shorter coil length. However, since coil set results in closer coil spacing, a significant amount of coil set can limit overall suspension travel as the coils will bind before full stroke is achieved.

**PRELOAD**

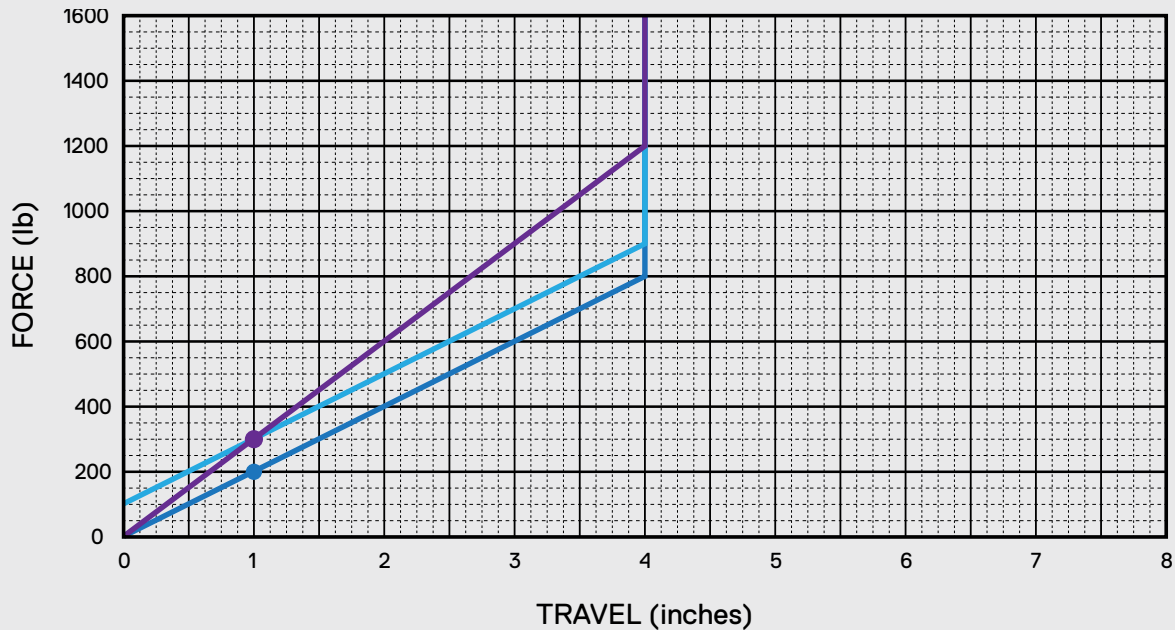

Blue line - 200 lb coil spring with 4" of compression before coil bind  
 Light blue line - same 200 lb coil spring with 1/2" preload  
 Purple line - 300 lb coil spring with 4" of compression before coil bind

**AIR SPRING**

An air spring is the result of a sealed chamber filled with air that has one or more of the chamber walls able to move in and out of the chamber. In suspension, the moving wall is called the *air piston*. During the compression stroke, the air piston presses against the air as it moves into the chamber. The amount of air molecules in the chamber remains the same but the volume of the chamber is reduced. The result is an increase of air pressure in the chamber. Any air pressure creates a proportional amount force against

the piston, opposing the force pushing the piston into the chamber. Eventually, the compression force against the piston will peak (end of compression stroke), then subside. At this point the increased air pressure will force the chamber to expand (rebound stroke). As the chamber expands, air pressure drops. The chamber continues to expand until there is no air pressure or a mechanical stop limits further expansion, known as *top out*.

$$\text{PRESSURE} = \frac{\text{AMOUNT OF AIR}}{\text{VOLUME}}$$

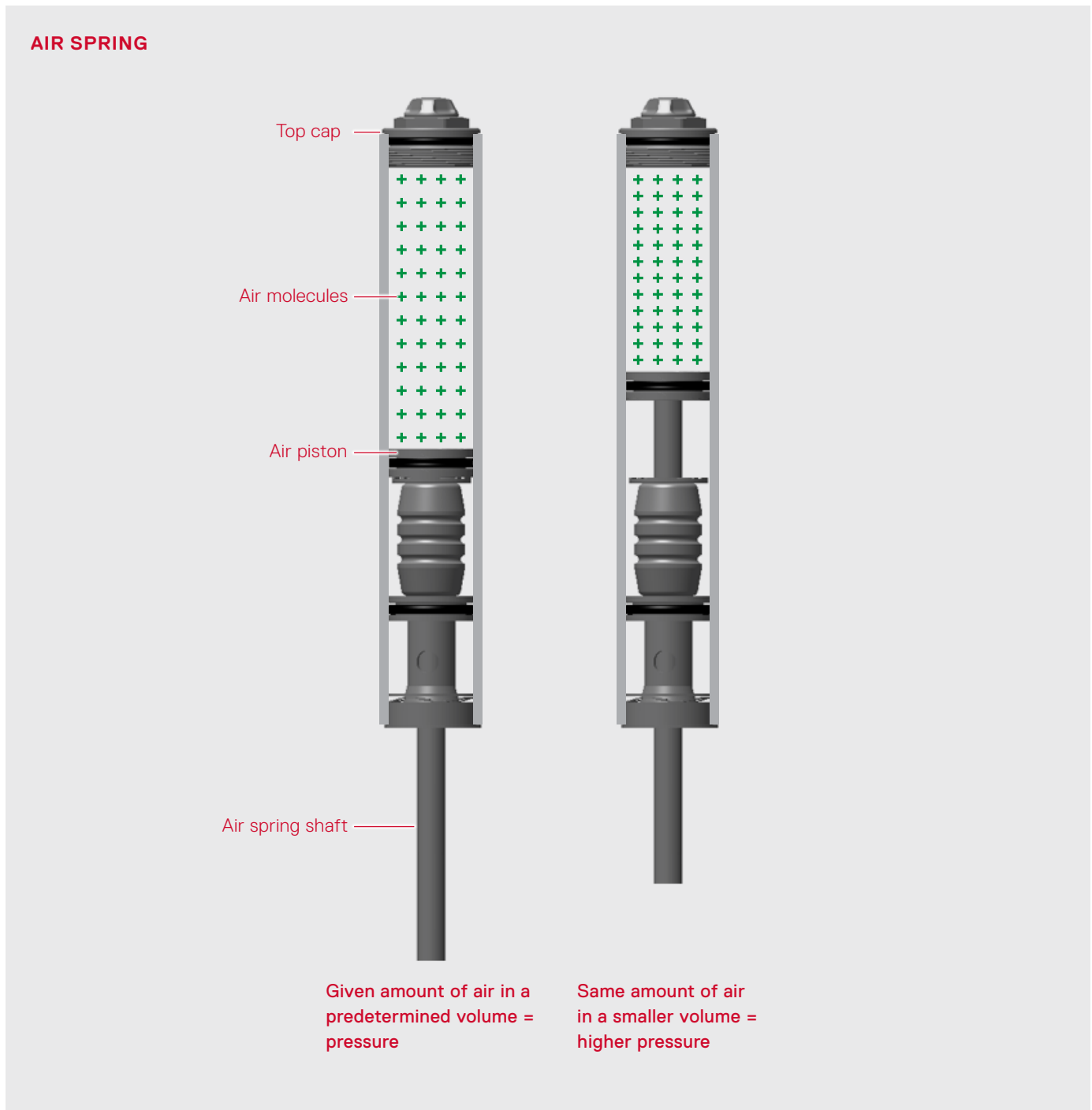



Unlike linear coil springs, air springs have a progressive spring curve. As an air spring is compressed, the amount of force required to compress the spring increases exponentially through the stroke.

Pressure in an air spring is determined by the ratio of air in the chamber and the volume of the chamber. The pressure at any point in the stroke can be calculated by using the the overall length of the air chamber and the air pressure at top out as a baseline; the percentage of change is the result of the amount of piston movement through the length of the air chamber.

For example: Take an air chamber that is four inches long and pressurize it to 100 psi. Move the piston into the air chamber two inches. This reduces the volume of the air chamber by 50%, which doubles the pressure. The remaining chamber length is two inches. Move the piston into the chamber one inch. This reduces the remaining volume of the air chamber by 50%, which doubles the pressure again. Continue to repeat this process of reducing the volume by half and doubling the pressure. The result is an exponential increase in air pressure throughout the stroke.

**AIR SPRING CURVE**

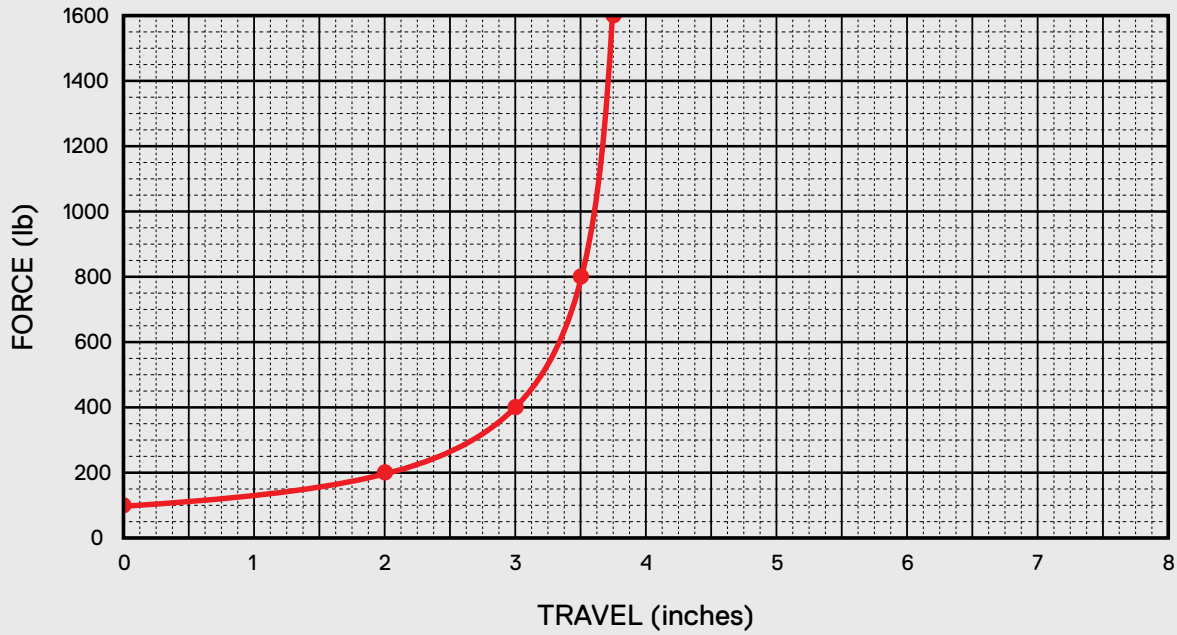

4" air chamber with 100 psi

**INITIAL VOLUME**

An important factor when considering air spring curve is the initial volume of the air chamber. A larger air chamber with the same piston diameter creates an air spring with a larger volume and more gradual spring curve. If the volume of the same air spring is reduced, the pressure increases more rapidly as the piston moves into the air chamber.

**AIR SPRINGS WITH DIFFERENT INITIAL VOLUMES**

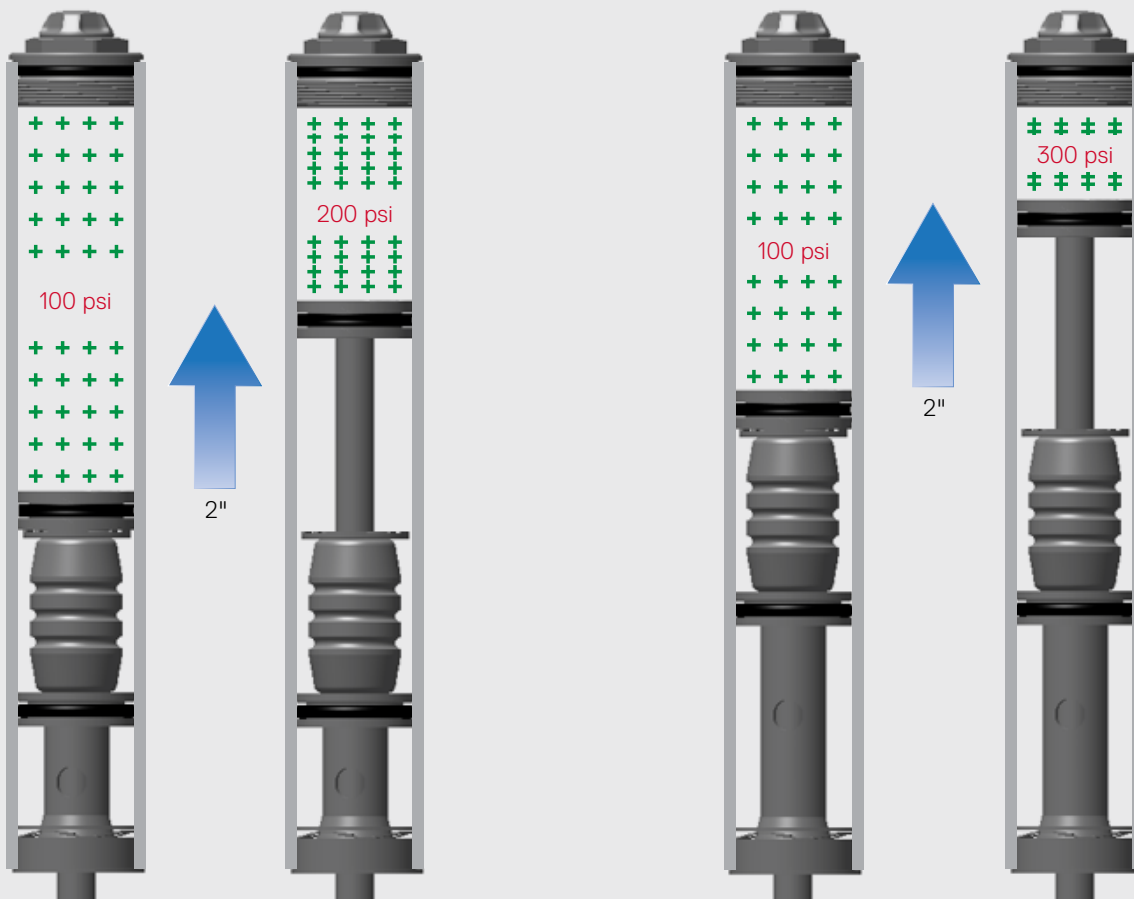

**High volume**

With a given starting pressure, piston movement reduces volume and raises pressure.

**Low volume**

At the same starting pressure, the same amount of piston movement in a smaller air chamber results in smaller volume and higher pressure.

**AIR SPRING CURVES WITH DIFFERENT INITIAL VOLUMES AND PRESSURES**

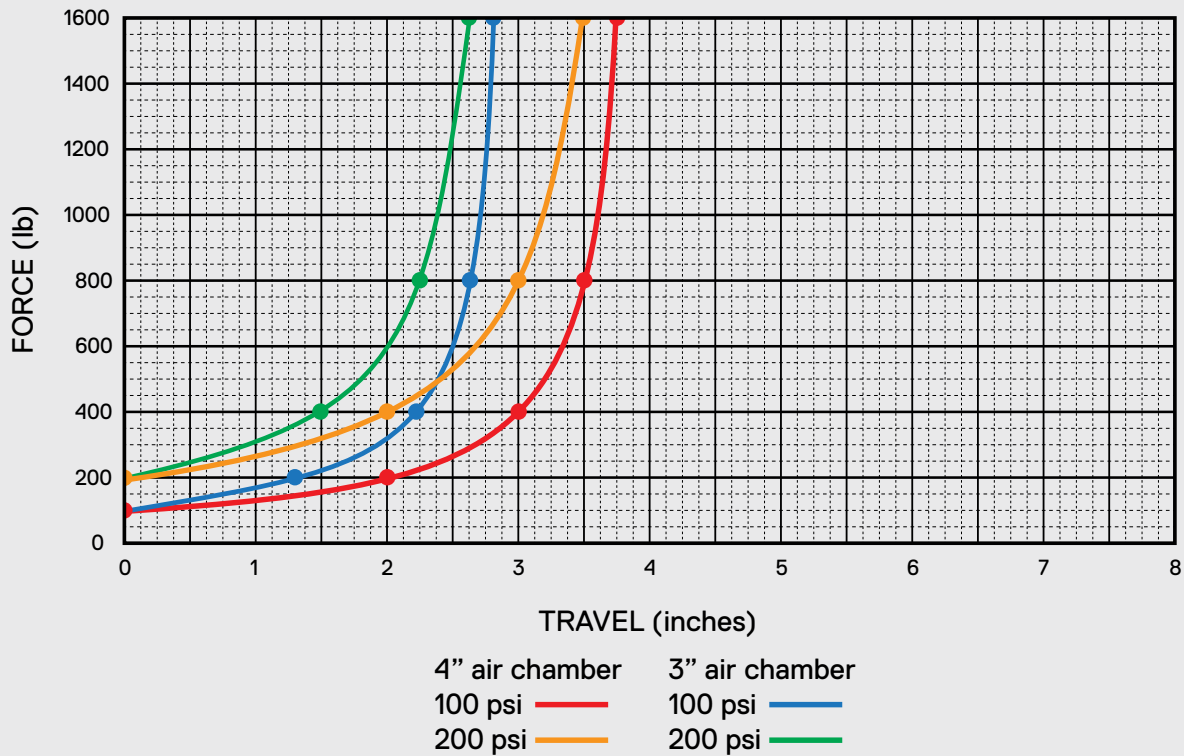

**PRESSURE VS. FORCE**

A common misconception is that the pressure in an air chamber is equal to the amount of force required to initiate compression. While this is not the case, the relationship between the two is proportional. A simple way to think about the relationship between input forces and spring pressure is to look at a common way that pressure is expressed, *pounds per square inch*, or in other words, *pounds divided by square*

*inches*. In this case, pounds is a measure of force and square inches is a measure of the surface area of the piston. By determining the area of the piston surface, taking into account any curvature of the surface, and dividing the force by the result, the amount of pressure required to counter the force can be calculated.

$$\text{PRESSURE} = \frac{\text{FORCE}}{\text{AREA}}$$

**BREAKAWAY FORCE IN AN AIR SPRING**

Pressurized air in a chamber creates force against all surfaces inside the chamber. The force acting against the piston creates a breakaway force. Because of this, an air spring can feel firm at the beginning of the stroke, similar to a preloaded coil.

**Negative spring** - A negative spring can be used to help the compression forces overcome the breakaway force at the beginning of the stroke. Any amount of force created by the negative spring reduces the amount of breakaway force by the same amount. A negative spring also reduces vibration caused by parts contacting each other at top out.

**Mechanical negative spring** - A coil or rubber negative spring can be configured to oppose the positive air spring. By placing a preloaded mechanical spring against the air piston opposite the air chamber, the breakaway force of the air spring is reduced by the amount of the mechanical spring preload force.

**Air negative spring** - An air negative spring can be configured to oppose the positive air spring. By placing a pressurized air chamber against the air piston opposite the positive air chamber, the breakaway force of the air spring is reduced by the amount of force created by the negative spring pressure.

Because the positive air spring and negative spring act against the same air piston, when the piston moves into the positive spring chamber, it moves out of the negative spring chamber, resulting in a drop in negative preload force or air pressure. Upon rebound, the greater positive spring pressure will push the piston back into the negative spring chamber until the pressures equalize or the suspension reaches top out.

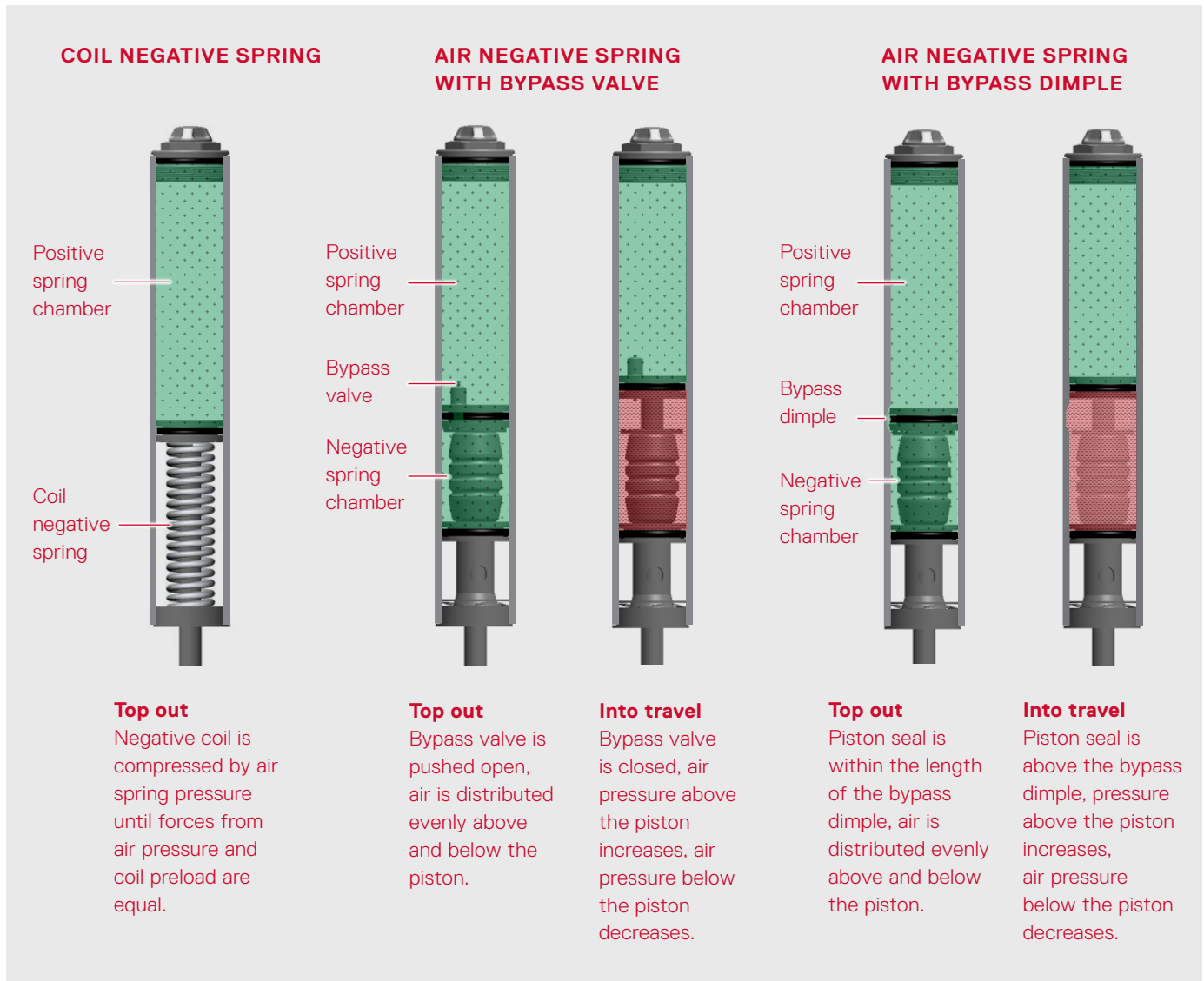

### EFFECT OF A NEGATIVE SPRING ON AIR SPRING CURVES

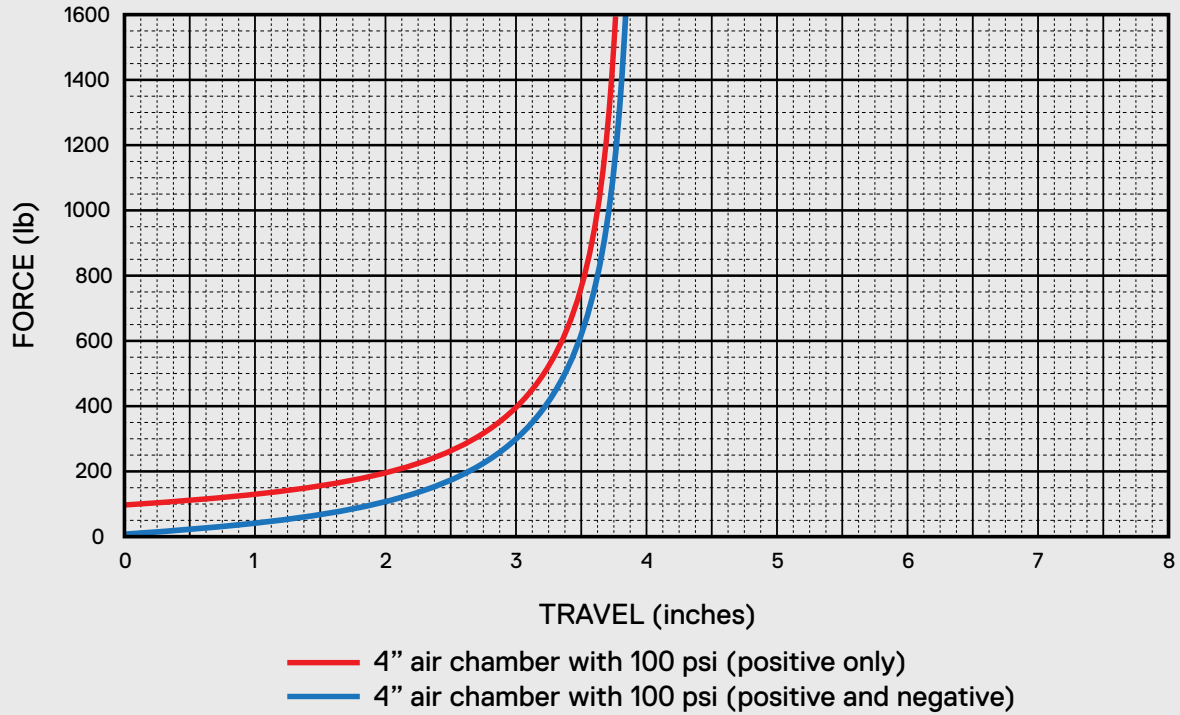

### SAG

The amount the suspension that compresses when the rider sits on the bike is the *sag*. Sag allows the suspension to not only compress but to also extend in order to maintain traction when unweighting over drops, dips, or when cornering. Sag can be controlled with coil spring rates, coil preload, or air pressure.



## ENERGY

Energy comes in many forms such as pressure, motion, and heat. While energy can not be eliminated, it can be changed from one form to another. The force of a bump acting upon suspension transmits energy into the suspension. This energy can be turned into friction by means of fluid flow-restriction. Friction changes the kinetic energy of the shock's motion into heat. This heat is dispersed into the fluid and is eventually released into the atmosphere.

## DAMPER FUNCTION

The rate at which a spring will compress is dependent on the velocity of the compressing force. The rate at which the spring will extend depends on the type of spring, how much energy is stored in it, and how fast the pressure exerted upon it is released. Typically these rates are too high to be effective in practical suspension. Shocks compressing and rebounding very quickly cause instability in the handling of the system they are designed to support. A hydraulic damper is a mechanism that utilizes friction caused by oil flow through ports to reduce the speed at which it can cycle through its stroke. Coupled with a spring, it can effectively control the rate at which a spring can compress and extend.

## CONSTRUCTION

A damper can be constructed in a variety of ways. Basic elements are:

- **Damper body** - To provide a chamber to house the damping components and fluid.
- **Fluid (oil)** - The damping medium. Hydraulic fluid creates resistance when cycled through ports and helps dissipate heat produced by friction.
- **Piston** - The piston contains oil flow ports and either moves back and forth through the oil inside of the damping chamber, or the oil is forced through the piston.
- **Seal head** - Closes the damper and is sealed to keep the oil in and contaminates out while still allowing for the damper shaft to move in and out of the damper body.
- **Damper shaft** - To couple the system that the suspension supports to the components in the damper body.

## OIL FLOW

Oil can be forced to flow by pressurizing it. Oil will flow at a certain rate depending on the pressure acting upon it, the size of any port the oil is forced to flow through, and oil viscosity, also known as *oil weight*. Fluids are non-compressible. As oil is pressurized, it will either flow or transmit the pressure to any other components within the system. By cycling a damper and moving the piston through an oil column, oil pressure is increased on one side of the piston. Ports create paths for the pressurized oil to flow to the other side of the piston, where oil pressure is lower. As the oil flows through these ports, friction is generated. Friction is what converts the energy being transmitted through the suspension into heat, effectively damping the motion of the suspension.

## DAMPER CONSTRUCTION



## DISPLACEMENT

In most systems, when the damper is cycled, the damper shaft moves in and out of the damper as it moves the piston through the oil. The shaft has mass. Introduction of this mass into a system that is already full of oil will create pressure inside of the damper. The damper must allow for displacement in order to release this pressure.

**Open System Displacement** - In an open system, oil is displaced to any available cavity in the system. The advantages to an open system are design simplicity, reduced heat build up, and the use of the damping oil as a lubricant for parts other than the damper. A disadvantage is the ability for the oil to mix with air, creating bubbles during stroke.

**Closed System Displacement** - In some closed systems, an internal floating piston, or *IFP*, is incorporated to compensate for shaft mass. The IFP seals oil in the damper. But unlike a seal head, which is stationary, the IFP is able to float, or move back and forth inside the damper. The IFP is also supported by a mechanical or pneumatic (gas) spring. When the shaft is introduced into the damper, the pressurized oil pushes the IFP

along the inside of the damper, compressing the IFP spring and allowing for oil displacement. Once the shaft is removed from the damper, the compressed spring backing the IFP will push the IFP and the oil column back to their original space.

A significant advantage to a closed system is the separation of oil and air, reducing the possibility of aeration. Another advantage is the ability for the IFP to compensate for fluid expansion as the oil is heated. Also, pressure on the oil from the IFP spring reduces the likelihood of air bubbles suspended in the fluid from expanding and interacting with the damping circuits. Disadvantages of an IFP design include system complexity, increased friction, and breakaway force created by gas pressure against the IFP.

In some systems, an expandable bladder can be used in place of an IFP. The advantage of a bladder is the lack of breakaway force created by IFP gas pressure.

**Through Shaft System** - In a through shaft design, shaft mass is introduced into one side of the damper while simultaneously being removed from the other side. This design eliminates the need for displacement compensation.



## VALVING AND SHIMS

With a constant oil viscosity and pressure, predetermined or variable port sizes will govern flow rate. To determine port size:

- Manufacture port to a given dimension.
- Adjust the amount of material blocking the port, effectively changing the port size.
- Stack sprung shims over the port. At a certain pressure, the shims will give way to oil flow. Various combinations of shims can tune oil flow. A sprung valve can be used in place of, or in conjunction with shims. The valve spring can also be adjusted by preloading it.

## CHECK VALVE

In most damping systems, it is important to separate rebound and compression flow paths so that adjustment of one circuit doesn't affect the performance of the other. In order to govern oil flow directionally, a check valve can be introduced into the system.

The purpose of a check valve is to allow for oil to flow through a piston in one direction while limiting or eliminating oil flow back through the same ports. This is accomplished by manufacturing a piston with a flow-specific port design. As oil flows through the piston, the check valve opens and allows for oil flow through only those ports that the valve regulates. Upon return oil flow, that valve will close and force the oil to flow through any other available port. A check valve can be constructed using shims or a sprung valve.

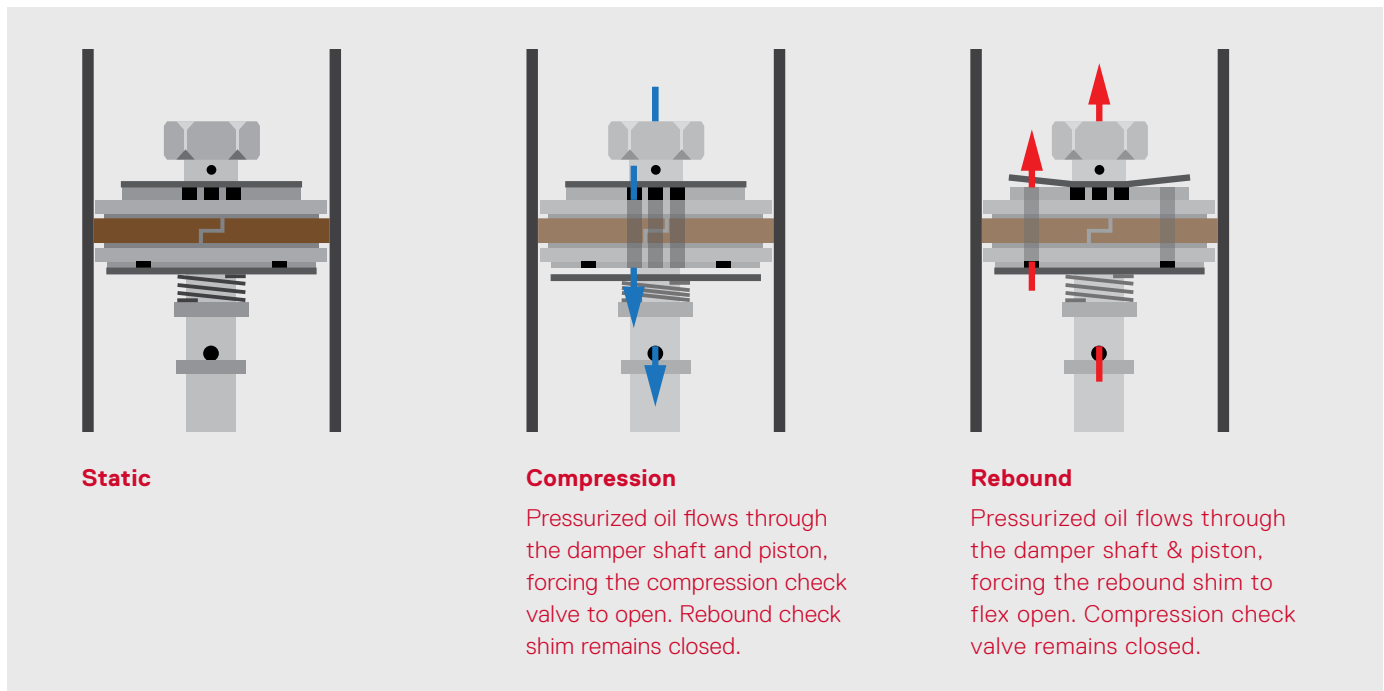

## BLOW-OFF

By changing the amount of spring pressure backing the check valve, oil flow can be regulated depending on oil pressure. For a check valve, more free flow is desirable as it minimizes the damping effect of the valve. For a blow-off valve, more spring pressure against the valve requires more oil pressure to open the valve and utilize the damping circuit it governs.

## STROKE SPEED SENSITIVITY

Some dampers are designed with multiple circuits to regulate low speed and high speed oil flow during either rebound or compression stroke. Oil pressure, generated by compression or rebound stroke, forces the oil to flow through every available path. The path that offers the least amount of resistance allows for oil flow first. As stroke speed increases, pressure also increases and the path of least resistance is no longer able to solely accommodate flow. At this point, increased oil pressure forces check valves that cover additional oil flow paths and damping circuits to open. By regulating the size of all of the ports and the spring pressure against the check valves, damping can be controlled for a variety of pressure scenarios.

**LOW SPEED DAMPING**

Regulation of primary oil flow at low pressure using a port of varying size.

- **Low Speed Compression** - Regulates oil flow in slow compression stroke speed scenarios such as rider weight shifts on the bike, and suspension compression during cornering or transitions.
- **Beginning Stroke Rebound** - Regulates rebound oil flow as the suspension approaches top out and is under low spring force.

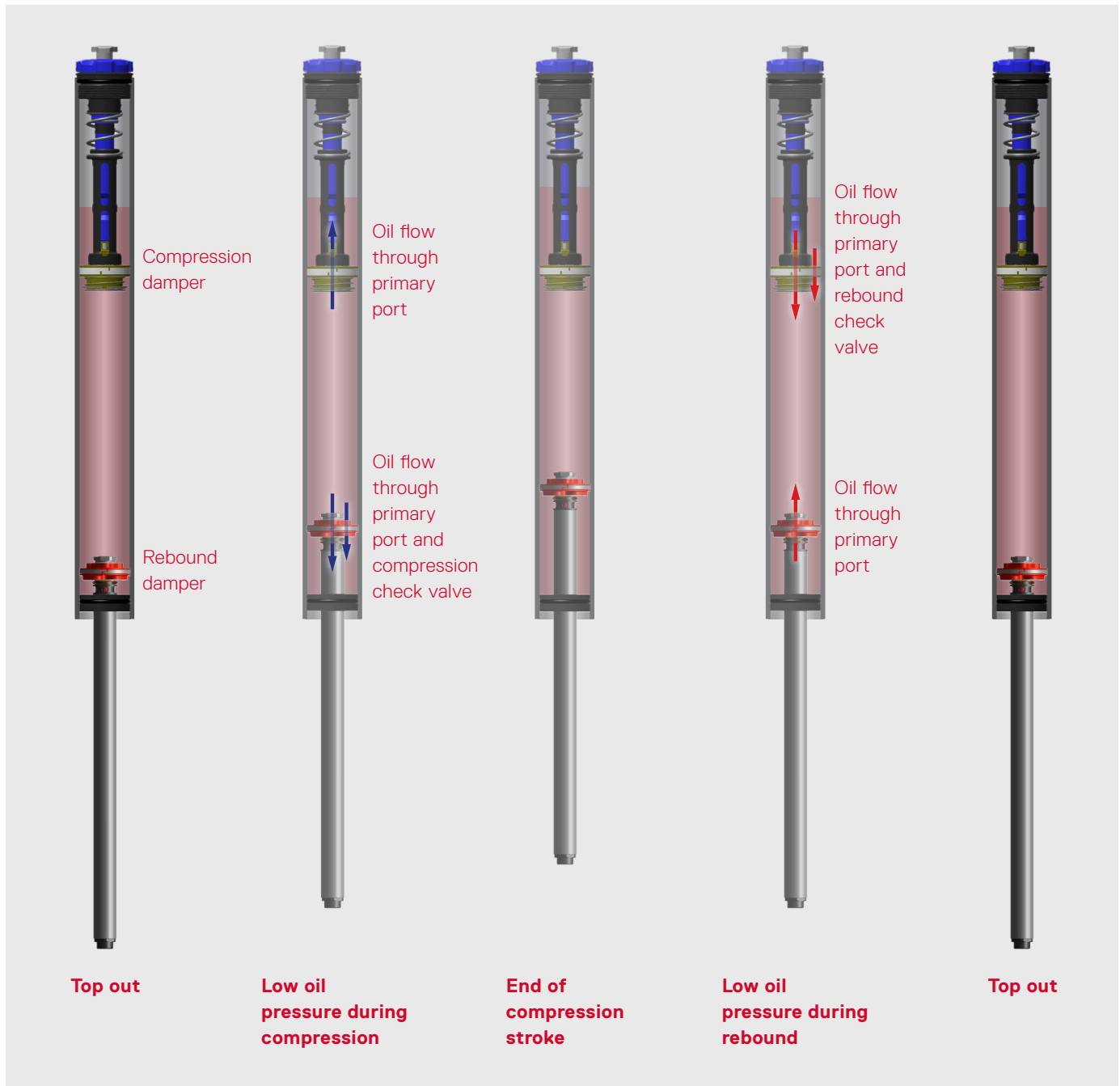

**HIGH SPEED DAMPING**

Regulation of secondary oil flow at high pressure using a blow-off valve.

- **High Speed Compression** - regulates oil flow in fast compression stroke speed scenarios such as bump impact or drop/jump landings.
- **Lockout** - restricts oil flow to prevent the suspension from compressing at all, or until a predetermined pressure threshold is overcome.

- **Platform** - similar to lockout, but with less force required to initiate suspension compression.
- **Ending Stroke Rebound** - regulates rebound oil flow while the suspension is deep into its travel and is under high spring force.





## EXTERNAL ADJUSTABILITY

Some dampers include an external adjustment for rebound, compression or both. Low pressure adjustment is usually achieved by using an adjuster needle or sleeve to block the primary orifice to varying degrees. Less blockage allows for more oil flow. More blockage reduces oil flow and causes oil pressure to increase. Once the oil pressure is high enough, the high pressure circuit is activated. The high pressure circuit can be externally adjusted with an adjuster that increases or decreases preload against the high pressure circuit's valve spring.

### EXTERNAL ADJUSTABILITY

#### Compression

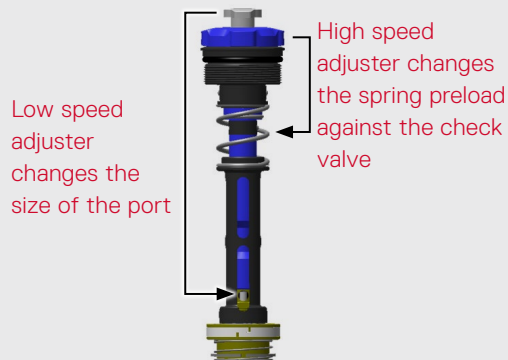

#### Rebound

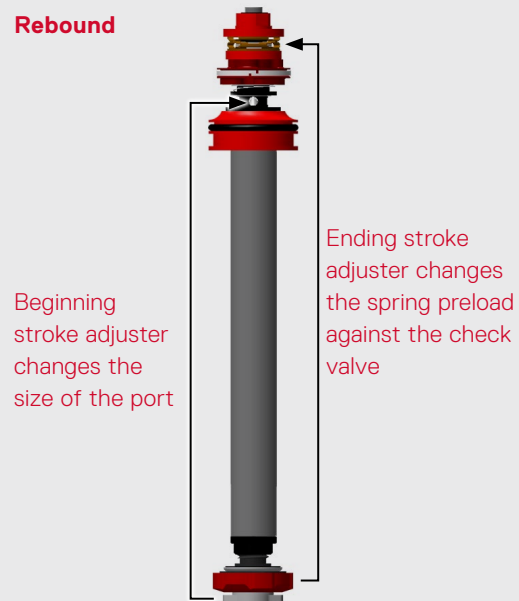

## GLIDE RING

A glide ring is a wear band, typically installed on a piston, that separates the piston from the inside wall of the damper body. Its primary function is to provide a coupling between the two components. In the case of a moving piston, or *dynamic piston*, the glide ring reduces friction as the piston is cycled through the damper. Typically, a glide ring provides a seal on the piston to regulate oil flow around the piston during compression and rebound. However, some designs allow for a flow path around the glide ring. Depending on the configuration, oil can flow between the inner wall of the damper body and the glide ring, between the piston and the glide ring, or both. In cases where oil flow around the piston is not needed, an o-ring can be used in place of the glide ring. However, this can create more friction if installed on a dynamic piston.

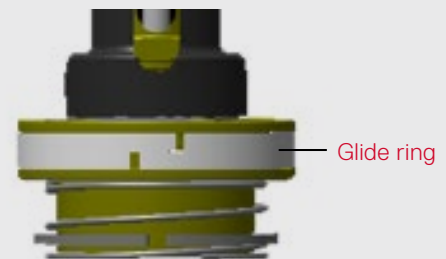

**SYSTEM CORRUPTION**

- **Temperature change** - As a damper is cycled, friction is generated and the oil heats up. Heat reduces the oil viscosity which reduces damping. Once the damper is at rest, the oil cools down and returns to its original viscosity. If the oil is cooled (cold weather), the viscosity is increased which increases damping. Over time, the repeated heating and cooling of oil will permanently break down the viscosity and any other performance oriented properties of the fluid. Once this occurs, the only way to restore the original damping characteristics is to replace the oil.
- **Aeration** - When a damper has gas, such as air or nitrogen, sealed in the system with the oil, gravity typically places the air on top of the oil. When the damper is cycled, the gas is pulled into the oil forming bubbles. When the suspension is at rest again, the bubbles will attempt to rise to the top again. This process repeats each time the suspension is actuated. If the damper is cycled rapidly enough that the bubbles cannot return to the top of the oil column, they will break up and disperse throughout the oil, creating a foam. This foam, being less dense than pure oil, will change the damping characteristics. In time, if allowed to rest, the bubbles will rise to the top of the oil column again, separating the gas from the fluid.

Temporary reduction in damping performance resulting from heat or aeration is known as *fade*.

- **Emulsification (emulsion)** - A permanent suspension of one substance into another. When contaminants such as water or gas are introduced into a column of oil, they tend to stay separate from the oil. However, rapid cycling of the damper eventually breaks down the contaminant until its particles are small enough to remain suspended in the oil. Once this happens, neither gravity nor filtration can separate the substances. The result is an overall change in viscosity and performance characteristics of the oil.

- **Cavitation** - Regardless of how well any fluid is purged of gas, extremely small bubbles can still be suspended in the fluid. Under extremely low pressure or high temperature, these bubbles will expand. In a damper, the bubbles flow with the oil and pass through ports, creating turbulence and noise.
- **Debris** - Any foreign matter in a damper can block orifices, altering oil flow and changing damping characteristics.
- **Hydraulic lock or Hydra-lock** - As a damper is cycled, mass is introduced into the system in the form of a damper shaft. As mass is introduced into the system, oil is forced to displace. Typically, oil can displace to any unoccupied cavity, or in the case of a closed damper, it can pressurize a compensator, such as a floating piston or bladder. However, if the oil is not able to displace, the damper shaft will not be allowed to enter the system, effectively locking the damper. Improper oil volume or contamination can contribute to hydraulic lock.
- **Spiking** - When port sizes are not able to accommodate oil flow during high speed stroke, the oil will rapidly build up at the ports, causing a sudden increase in oil pressure. The result is a temporary but drastic increase in the damping effect.

**LOAD PLACEMENT**

**Fork** - When the front wheel comes in contact with and rolls over a bump, load is placed on the fork in a circular path, front to rear with the wheel center as the axis. Side load and twisting, or axial load, is also possible depending on various factors.

**Rear shock** - When a rear shock is actuated, load can be placed on it from a variety of different directions depending on the shock mounts and overall frame design.

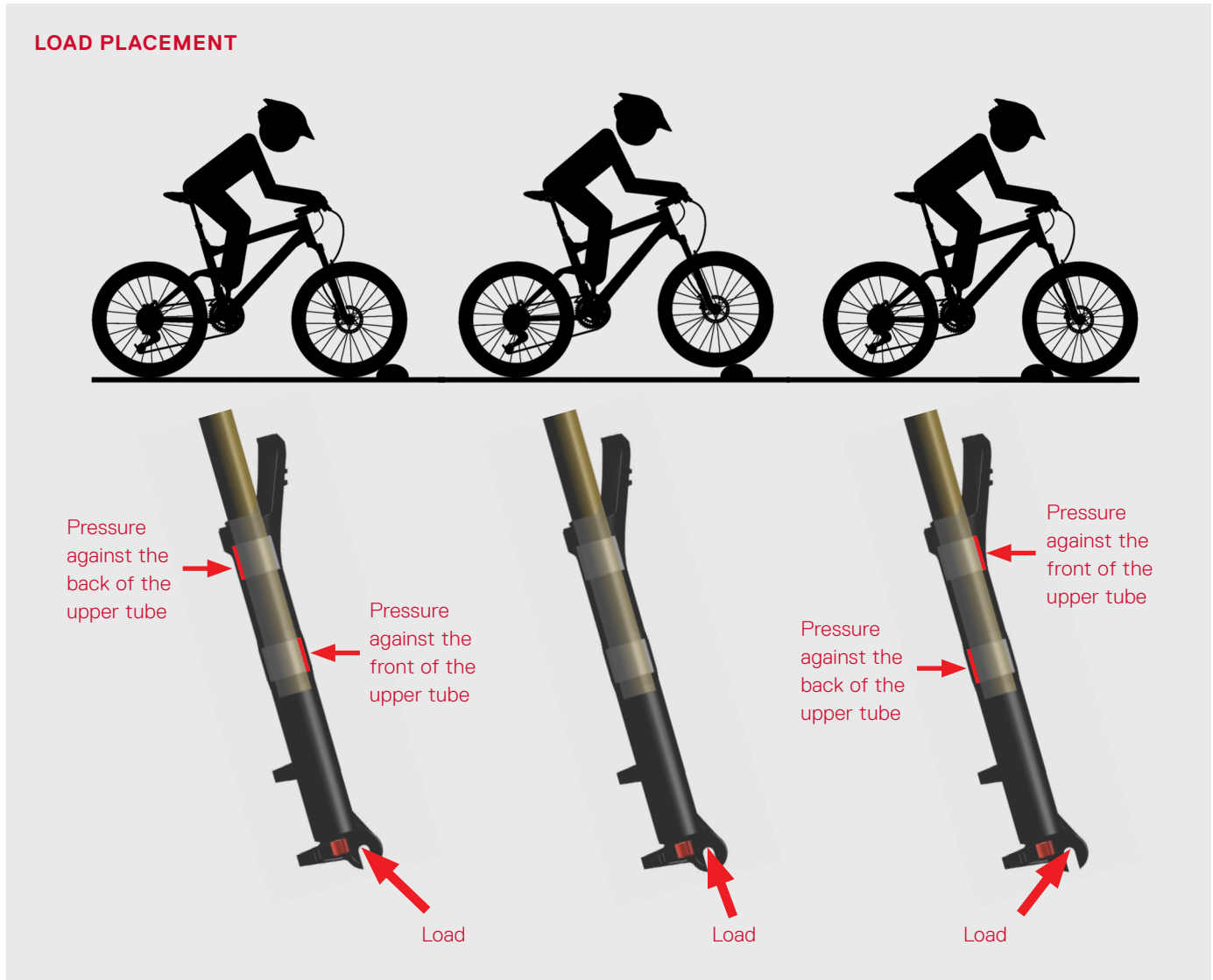
**BUSHING FUNCTION****Fork**

- To provide a secure contact surface for the lower legs to interface with the upper tubes.
- To eliminate lateral movement of the upper tubes while facilitating the smoothest possible vertical movement.

**Rear shock**

- Mounts - To provide a secure contact surface for the eyelet to interface with the frame mounting hardware. To eliminate lateral movement of the eyelet while facilitating the smoothest possible rotational movement.
- Stroke - To provide a secure contact surface for the shaft to interface with the seal head. To eliminate lateral movement of the shaft while facilitating the smoothest possible vertical movement.

## FRICTION REDUCING PROPERTIES OF A BUSHING

- **Inner coating** - A bushing may be made of steel, aluminum, or plastic, depending on function and cost. If the bushing is made of metal, the contact surfaces can be coated with a slick material specifically designed to reduce friction and wear. When this coating eventually wears, the bushing should be replaced to eliminate play between the mating parts, or in the case of extreme wear, metal-on-metal contact. A plastic bushing, already being a slick material, needs no coating. Lubrication can be used with a bushing to further reduce friction and to extend the life of the bushing.
- **Bushing size** - When a bushing moves against another surface, the load against the bushing, the smoothness of the surfaces, and the types of material will produce a certain amount of friction. This friction will wear the contact surface of the bushing. By increasing the length of the overall bushing, the contact surface is increased. With more contact surface, the friction is distributed over a greater area and wear is reduced. In addition to reduced wear, longer bushings also increase overall fork stiffness by creating more overlap between the parts.
- **Oil slots** - A bushing with internal channels, or *slots*, allows lubrication to circulate and cover moving parts more consistently. In addition to reduced friction, oil circulation also displaces the heat generated by friction.

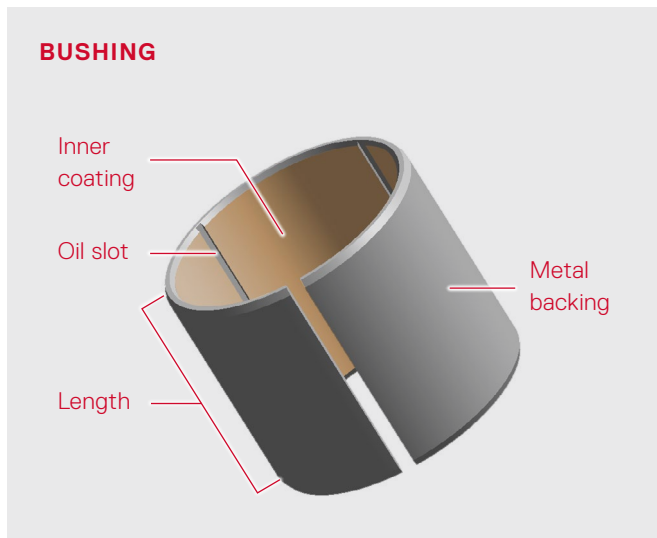

## OTHER FRICTION ELEMENTS

- **Glide ring** - In addition to managing oil flow for damping, a glide ring can also serve as a bushing between a moving piston and the tube it moves in. In some instances, by manufacturing the piston out of the same material used for glide rings, the piston acts as a glide surface itself and doesn't require a glide ring or bushing.
- **Tube treatment** - By treating tubing with certain materials, tube surfaces can be made smoother, effectively reducing friction when moving against other parts. Different types of treatments such as hard anodization, PTFE impregnation, chrome plating, and nitride reduce friction to different degrees and wear at different rates.
- **Seals and static friction, or stiction** - Seals such as o-rings, u-cup seals, wipers, etc., prevent migration of lubrication and contaminants. Specific seal pressures are required to accommodate certain design requirements. If this seal pressure is applied to moving parts, a certain amount of friction is inevitable. This friction creates a "sticky" feel. Some of this friction can be eliminated with lubrication, but there will always be some friction in a properly sealed system.
- **Rear shock bushings and mounting torque** - When mounting a rear shock that is designed to rotate in the frame, it is important the correct mounting bolt torque is achieved to allow the shock to rotate freely while not allowing any side-to-side movement. A shock that has been mounted with overly-tightened mounting bolts will bind rather than rotate. This will cause premature wear on the bushings and possibly flex the shock enough to allow oil to leak.

---

## STEERER TUBE

The steerer tube fastens the fork to the bicycle frame, headset, and stem.

**Threaded and non-threaded** - Some steerer tubes have external threads at the top that integrate with the headset. For these threaded systems, the stem clamps to the inside of the steerer tube. However, most modern suspension fork steerer tubes use a non-threaded headset interface and stem that clamps around the steerer tube.

**Diameter** - Common suspension fork steerer tube diameters are 1, 1.125, 1.25 and 1.5 inches. Some steerer tubes have a 1.25 inch diameter at the top that tapers to a 1.5 inch diameter at the base.

**Length** - The final cut length of the steerer tube depends on the length of the head tube and the headset and spacer stack height. On non-threaded systems, the height of the stem also factors into the steerer tube length.

---

## CROWN

The crown functions as the coupler between the steerer tube and the upper tubes. It serves a critical role in creating overall fork strength and stiffness.

**Material removal** - The crown can be hollowed out or scalloped in specific locations to reduce weight without significantly affecting the overall strength or stiffness.

**Overlap** - Refers to the contact area of the crown and upper tube coupling. Increased overlap can increase rigidity, but also adds weight, as crown material is also increased.

---

## UPPER TUBES

The upper tubes attach to the lower leg assembly and house the spring and damper system. They also serve a critical role in creating overall fork strength and stiffness.

**Tube diameter** - The size of the chassis is significantly influenced by the diameters of the upper tubes. Larger upper tube diameters increases strength and stiffness, but require larger crowns and lower legs, which add weight to the fork.

**Upper tube wall thickness** - Another factor that affects strength, stiffness and weight is the wall thickness of the upper tubes. Tubes with variable wall thickness target specific strength and weight requirements along the length of a single tube. Because the outer surface of the upper tubes interacts with lower leg seals and bushings, the change in wall thickness must occur internally. When housing a damper or air spring inside of a tube with varying wall thicknesses, an internal tube must be used to maintain a consistent diameter for the piston, piston seals, and glide rings.

---

## CROWN-STEERER-UPPER TUBE (CSU)

The coupling of the crown, steerer tube, and upper tubes either by press-fit, bonding, or a clamp/bolt method is referred to as a crown/steerer/upper tube assembly, or *CSU*.

---

## LOWER LEGS

**Assembly** - Typically the lower leg assembly is cast as one piece. However, some older designs use bolts to couple the legs and brake arch.

**Wheel Mounts** - The lower leg assembly mounts to both the front wheel and brakes. For the wheel, some lower legs have dropouts to support a 9 mm bolt-on or quick release axle, while others incorporate a 15 or 20 mm thru-axle mounting system for more rigidity and strength.

**Brake Mounts** - Some lower leg assemblies include International Standard (IS) or Post disc tabs for disc brakes, brake bosses for cantilever or linear pull brakes, cable housing stops for cantilever brakes, and mounting holes for side pull brakes. Specific combinations of brake and wheel mounts are made available depending on the intended use of the fork.

**Form** - Specific placement of material on lower legs can be used to increase strength and rigidity, reduce weight, and create aesthetic effect.



## TRAVEL

Travel refers to the effect of the shock's stroke on overall wheel movement. On a suspension fork, the wheel is mounted directly to the shock, therefore the stroke and the travel are the same. In a rear suspension system, any number of levers and pivots can be incorporated in the frame between the shock and the wheel. Depending on the

geometry of the lever system, the resulting wheel travel can be different than the stroke. This relationship between the wheel travel and shock stroke is expressed as a ratio. For example, a suspension system that uses a one inch stroke shock, coupled with a system of levers to produce two inches of rear wheel travel is referred to as a 2:1 ratio design.

### REAR SUSPENSION RATIOS

**1:1 Ratio**  
Shock compresses 1 inch, wheel moves 1 inch

**2:1 Ratio**  
Shock compresses 1 inch, wheel moves 2 inches

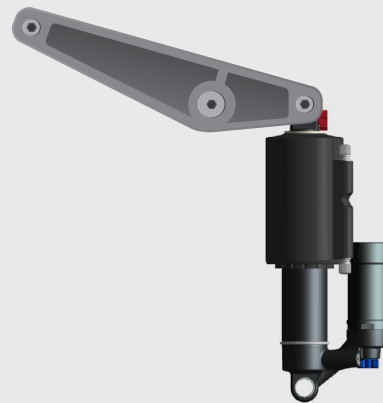
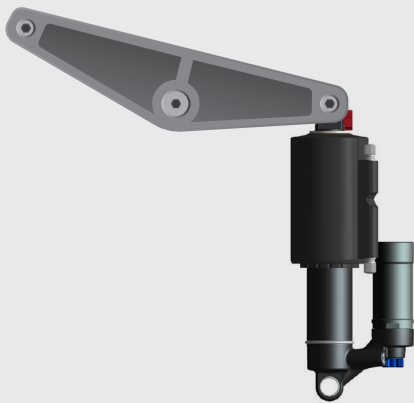
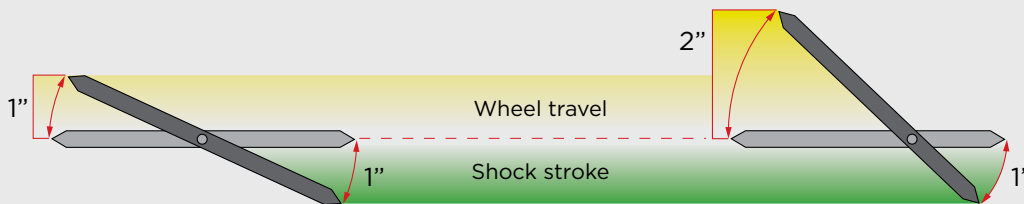

### Rising and falling rate suspension

As the rear suspension advances through its travel, the leverage ratio can change.

**Rising rate** - If the leverage decreases, the input forces are de-amplified by a factor equal to the ratio. This makes the shock harder to compress as the suspension progresses deeper into its travel. Also, the wheel travel increases in relation to the shock's stroke. Rising rate systems can be paired with a coil shock as the linear nature of the coil spring rate can compensate for the digressive increase of bump forces so that all of the shock's stroke can be utilized. A large volume air shock can also be used.

**Falling rate** - If the leverage increases, the input forces are amplified by a factor equal to the ratio. This makes the shock easier to compress as the suspension progresses deeper into its travel. Also, the wheel travel decreases in relation to the shock's stroke. Falling rate systems can be paired with a low volume air shock as the progressive nature of the air spring rate can compensate for the progressive increase of bump forces so that the shock isn't able to bottom out too easily. A progressively wound or multi-rate coil can also be used.

**Fork Travel** - Fork travel settings affect the overall length of the fork. When travel is increased, the fork length must also increase to allow for the additional stroke length. Any change in fork length affects the height of everything around the rear wheel, and subsequently, angular relation of the entire bicycle to the ground. Changes in fork length also affect *trail* of the front wheel.

**Trail** - Trail is the relationship between the imaginary point where the steering axis contacts the ground and the point where the tire contacts the ground, or *contact patch*. As the tire trails behind the steering axis, it has a tendency to self-center behind the axis, similar to the wheel on an offset caster trailing behind the steering bearing. This self-centering effect creates stability when steering the bike, which is advantageous at high speeds and on rough terrain.

Trail also has an effect on how responsive the steering is to rider input. Because trail creates more stability, the steering is resistant to input from both the terrain and the rider. This is also advantageous at high speeds and in challenging terrain as it reduces the likelihood of oversteering and overcorrection.

The overall amount of trail is determined by a number of factors. On most mountain bikes and forks, the main factors that determine trail are head angle, rake, and offset.

- Head angle – Angle of the head tube in relation to horizontal, determined by a combination of frame geometry, fork length and tire/wheel size
- Rake – Angle of the fork legs in relation to vertical
- Offset – Distance from steering axis to the center of the fork legs
- Axle offset – Distance from axle to the center of the fork legs

**Weight distribution** - In addition to steering responsiveness, longer forks allow the rider's weight to stay further back on the bike, reducing the risk of the rider going over the bars when riding downhill and contacting rough terrain.

**Travel and climbing/descending** - Because longer travel forks provide more shock absorption, more stability, and place rider weight further back on the bike, they are better suited for downhill riding. Because shorter travel forks are more responsive to steering input and place rider weight further forward, they are better suited for climbing.

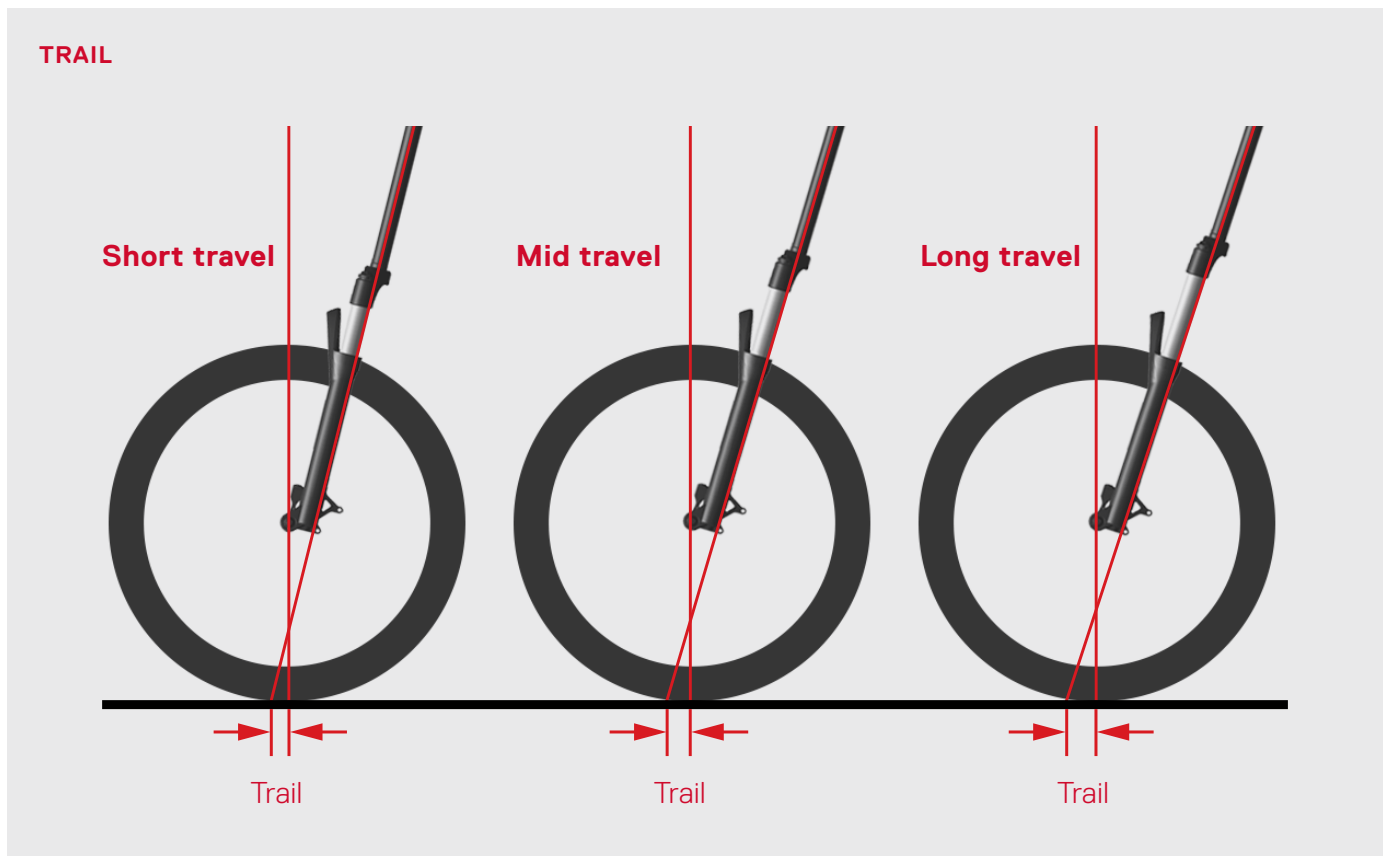

**Intended use** - While some aspects of suspension can be manipulated to meet the needs of specific riders, riding styles, and terrain, there are limitations to customization. For example, some forks are designed to be lightweight for cross-country riding. While the amount of travel might be adjustable, the fork will likely not be able to extend to a length ideal for downhill racing as this would require a more robust chassis and larger components that would make the fork too heavy for cross-country riding.

Conversely, a fork that is designed for cross-country use can be used for downhill racing, but the attention to weight savings and more climbing appropriate geometry make such a fork a poor choice for this application.

**Spring** - When tuning the spring, rider weight is the primary factor to account for. Sag can be used as a measure of proper spring rate for the rider. Typically 10-30% of the total travel should be used for sag. This allows the wheel to maintain traction over a variety of terrain without using too much travel reserved for shock absorption. The spring setup should be finalized before any other aspect of the suspension is adjusted.

**Fork travel** - When climbing, short travel is advantageous as the geometry allows for quick, easy steering around terrain at slow speeds, as well as keeping the rider weight more forward to maintain better front wheel traction. When descending, longer travel is advantageous as increased shock absorption capability is needed when contacting obstacles at higher speeds. Also, the geometry provides more steering stability to reduce the possibility of over-steering and over-correction. Finally, the longer front end places the rider weight further back on the bike to reduce the possibility of rider ejection off the front of the bike.

**Damping and travel preservation** - A significant concern when tuning damping is the preservation of travel. Suspension has a finite amount of travel and if too much is used too soon, the suspension is rendered ineffective when it is still needed. By tuning damping properly, travel can be preserved for multiple compressions.

### Rebound damping

- Beginning stroke - Too little beginning stroke rebound can create a pogo effect that makes the suspension feel bouncy and disrupts traction. Too much beginning stroke rebound can prevent the fork from extending quickly enough to have enough travel for the next impact or weight shift. Repeated compression strokes with too much beginning stroke rebound can cause the fork to pack-up to the point where there is little to no travel available and the head angle is steeper than it is intended to be.
- Ending stroke - In the event that the beginning stroke rebound is optimally tuned for traction purposes but does not allow the fork to extend quickly enough to prevent packing-up deeper into the travel, ending stroke rebound can be used to temporarily bypass the beginning stroke rebound setting and allow the fork to extend more quickly before re-engaging the beginning stroke rebound.

### Compression damping

- Low speed - Too little low speed compression allows the suspension to use too much travel when compressing during weight shifts such as body movement, braking, cornering, and transitions. Too much low speed compression makes the suspension feel harsh on impact.
- High speed compression - Too little high speed compression allows a succession of impacts such as bumps, dips, and landings to use too much travel. Too much high speed compression makes the suspension feel harsh on impact.
- Lockout/platform damping - When climbing, it may be advantageous to limit the function of the suspension in order to maintain a constant flow of energy from the rider to the drivetrain without the suspension absorbing any of this energy. A lockout uses an aggressively tuned high speed compression circuit to prevent the suspension from compressing up to a predetermined force threshold, or blowoff point. Platform damping functions in a similar manner but allows the threshold to be adjusted. A lighter platform setting locks the suspension on smooth terrain, but allows for compression on small impacts. A firmer platform setting requires bigger impacts to compress the suspension.

## COMMON TUNING MISCONCEPTIONS

- **Spring rate and coil preload** - In the event that the spring rate is too low for the rider, preloading the coil can make the suspension feel firmer. However, preload introduces a required breakaway force which can make the suspension feel harsh when initiating compression. Excessive preload can also lead to harsh top out, premature coil set, and premature coil bind which can reduce travel as the spring binds before the suspension can move through its entire stroke.
- **Spring rate and rebound damping** - The spring is what creates rebound force, so when adjusting the spring rate, the rebound damping will need to be adjusted proportionally.
- **Spring rate and compression damping** - In the event that the spring rate is too low for the rider, compression damping can make the suspension feel firmer. However, compression damping does not support the rider's weight, so while the suspension might feel firmer, there will be too much sag and not enough travel. Excessive low speed compression can also make the suspension feel harsh on impact.
- **Shim/oil tuning** - Most high performance suspension systems allow for a wide range of external adjustability which eliminates the need for damping shim tuning or varying oil weights. In the event that desired adjustment is beyond the capability of external adjusters, any changes in shim configurations or oil weight will affect other aspects of the suspension and may be beyond the performance or structural capability of the entire suspension system.

**SRAM.COM**